





















オダワラ・キャッスル杯 団体 A 予選リーグ

A ブロック		1	2	3	4	勝	負	勝G	負G	順位
1	東北 宮城県		② $\begin{array}{l} \textcircled{4}-0 \\ \textcircled{4}-0 \\ 2-4 \end{array}$	③ $\begin{array}{l} \textcircled{4}-3 \\ \textcircled{4}-1 \\ \textcircled{4}-1 \end{array}$	③ $\begin{array}{l} \textcircled{4}-0 \\ \textcircled{4}-3 \\ \textcircled{4}-0 \end{array}$	3	0			1
2	岩手 岩手県	1 $\begin{array}{l} 0-4 \\ 0-4 \\ \textcircled{4}-2 \end{array}$		② $\begin{array}{l} \textcircled{4}-2 \\ 3-4 \\ \textcircled{4}-2 \end{array}$	③ $\begin{array}{l} \textcircled{4}-1 \\ \textcircled{4}-2 \\ \textcircled{4}-0 \end{array}$	2	1			2
3	前橋商業 群馬県	0 $\begin{array}{l} 3-4 \\ 1-4 \\ 1-4 \end{array}$	1 $\begin{array}{l} 2-4 \\ \textcircled{4}-3 \\ 2-4 \end{array}$		③ $\begin{array}{l} \textcircled{4}-3 \\ \textcircled{4}-1 \\ \textcircled{4}-0 \end{array}$	1	2			3
4	松山 埼玉県	0 $\begin{array}{l} 0-4 \\ 3-4 \\ 0-4 \end{array}$	0 $\begin{array}{l} 1-4 \\ 2-4 \\ 0-4 \end{array}$	0 $\begin{array}{l} 3-4 \\ 1-4 \\ 0-4 \end{array}$		0	3			4

B ブロック		1	2	3	4	勝	負	勝G	負G	順位
1	霞ヶ浦 茨城県		0 $\begin{array}{l} 1-4 \\ 3-4 \\ 1-4 \end{array}$	③ $\begin{array}{l} \textcircled{4}-3 \\ \textcircled{4}-3 \\ \textcircled{4}-1 \end{array}$	③ $\begin{array}{l} \textcircled{4}-1 \\ \textcircled{4}-1 \\ \textcircled{4}-2 \end{array}$	2	1			2
2	東北 B 宮城県	③ $\begin{array}{l} \textcircled{4}-1 \\ \textcircled{4}-3 \\ \textcircled{4}-1 \end{array}$		② $\begin{array}{l} \textcircled{4}-0 \\ 3-4 \\ \textcircled{4}-0 \end{array}$	② $\begin{array}{l} \textcircled{4}-1 \\ 3-4 \\ \textcircled{4}-3 \end{array}$	3	0			1
3	昭和学院 千葉県	0 $\begin{array}{l} 3-4 \\ 3-4 \\ 1-4 \end{array}$	1 $\begin{array}{l} 0-4 \\ \textcircled{4}-3 \\ 0-4 \end{array}$		1 $\begin{array}{l} 0-4 \\ \textcircled{4}-3 \\ 1-4 \end{array}$	0	3			4
4	横浜創英 神奈川県	0 $\begin{array}{l} 1-4 \\ 1-4 \\ 2-4 \end{array}$	1 $\begin{array}{l} 1-4 \\ \textcircled{4}-3 \\ 3-4 \end{array}$	② $\begin{array}{l} \textcircled{4}-0 \\ 3-4 \\ \textcircled{4}-1 \end{array}$		1	2			3





C ブロック		1	2	3	4	勝	負	勝G	負G	順位
1	学法石川 福島県		② $\begin{array}{l} \textcircled{4}-2 \\ \textcircled{4}-0 \\ 1-4 \end{array}$	1 $\begin{array}{l} \textcircled{4}-1 \\ 2-4 \\ 3-4 \end{array}$	1 $\begin{array}{l} 3-4 \\ \textcircled{4}-0 \\ 2-4 \end{array}$	1	2			3
2	知徳 静岡県	1 $\begin{array}{l} 2-4 \\ 0-4 \\ \textcircled{4}-1 \end{array}$		1 $\begin{array}{l} \textcircled{4}-3 \\ 1-4 \\ 0-4 \end{array}$	1 $\begin{array}{l} 0-4 \\ 0-4 \\ 4-3 \end{array}$	0	3			4
3	高崎商 群馬県	② $\begin{array}{l} 1-4 \\ \textcircled{4}-2 \\ \textcircled{4}-3 \end{array}$	② $\begin{array}{l} 3-4 \\ \textcircled{4}-1 \\ \textcircled{4}-0 \end{array}$		② $\begin{array}{l} 1-4 \\ \textcircled{4}-0 \\ \textcircled{4}-2 \end{array}$	3	0			1
4	相洋 神奈川県	② $\begin{array}{l} \textcircled{4}-3 \\ 0-4 \\ \textcircled{4}-2 \end{array}$	② $\begin{array}{l} \textcircled{4}-0 \\ \textcircled{4}-0 \\ 3-4 \end{array}$	1 $\begin{array}{l} \textcircled{4}-1 \\ 0-4 \\ 2-4 \end{array}$		2	1			2





D ブロック		1	2	3	4	勝	負	勝G	負G	順位
1	黒沢尻工 岩手県		1 $\begin{array}{l} 3-4 \\ \textcircled{4}-3 \\ 3-4 \end{array}$	1 $\begin{array}{l} \textcircled{4}-3 \\ 1-4 \\ 1-4 \end{array}$	1 $\begin{array}{l} \textcircled{4}-3 \\ 0-4 \\ 0-4 \end{array}$	0	3			4
2	富士宮北 静岡県	② $\begin{array}{l} \textcircled{4}-3 \\ 3-4 \\ \textcircled{4}-3 \end{array}$		0 $\begin{array}{l} 1-4 \\ 1-4 \\ 2-4 \end{array}$	1 $\begin{array}{l} 2-4 \\ \textcircled{4}-0 \\ 2-4 \end{array}$	1	2			3
3	東海大相模 神奈川県	② $\begin{array}{l} 3-4 \\ \textcircled{4}-1 \\ \textcircled{4}-1 \end{array}$	③ $\begin{array}{l} \textcircled{4}-1 \\ \textcircled{4}-1 \\ \textcircled{4}-2 \end{array}$		② $\begin{array}{l} 3-4 \\ \textcircled{4}-1 \\ \textcircled{4}-2 \end{array}$	3	0			1
4	豊川 愛知県	② $\begin{array}{l} 3-4 \\ \textcircled{4}-0 \\ \textcircled{4}-0 \end{array}$	② $\begin{array}{l} \textcircled{4}-2 \\ 0-4 \\ \textcircled{4}-2 \end{array}$	1 $\begin{array}{l} \textcircled{4}-3 \\ 1-4 \\ 2-4 \end{array}$		2	1			2





E ブロック		1	2	3	4	勝	負	勝G	負G	順位
1	静岡商 静岡県		1 $\begin{array}{l} 3-4 \\ 0-4 \\ \textcircled{4}-3 \end{array}$	③ $\begin{array}{l} \textcircled{4}-1 \\ \textcircled{4}-3 \\ \textcircled{4}-0 \end{array}$	② $\begin{array}{l} \textcircled{4}-0 \\ 3-4 \\ \textcircled{4}-3 \end{array}$	2	1			2
2	秋田北鷹 秋田県	② $\begin{array}{l} \textcircled{4}-3 \\ \textcircled{4}-0 \\ 3-4 \end{array}$		1 $\begin{array}{l} 3-4 \\ 2-4 \\ \textcircled{4}-3 \end{array}$	② $\begin{array}{l} \textcircled{4}-3 \\ \textcircled{4}-3 \\ 2-4 \end{array}$	2	1			1
3	柏市立柏 千葉県	0 $\begin{array}{l} 1-4 \\ 3-4 \\ 0-4 \end{array}$	② $\begin{array}{l} \textcircled{4}-3 \\ \textcircled{4}-2 \\ 3-4 \end{array}$		1 $\begin{array}{l} \textcircled{4}-1 \\ 2-4 \\ 2-4 \end{array}$	1	2			4
4	武相 神奈川県	1 $\begin{array}{l} 0-4 \\ \textcircled{4}-3 \\ 3-4 \end{array}$	1 $\begin{array}{l} 3-4 \\ 3-4 \\ \textcircled{4}-2 \end{array}$	② $\begin{array}{l} 1-4 \\ \textcircled{4}-2 \\ \textcircled{4}-2 \end{array}$		1	2			3

会場: 小田原テニスガーデン

オダワラ・キャッスル杯団体A予選リーグ

F ブロック		1	2	3	4	勝	負	勝G	負G	順位
1	高崎 群馬県		② 1-4 ④-2 ④-1	0 0-4 0-4 2-4	1 ④-0 3-4 2-4	1	2			4
2	立花学園 神奈川県	1 ④-1 2-4 1-4		② 0-4 ④-3 ④-0	② ④-2 2-4 ④-1	2	1			1
3	千葉黎明 千葉県	③ ④-0 ④-0 ④-2	1 ④-0 3-4 0-4		1 ④-1 1-4 0-4	1	2			3
4	浜名 静岡県	② 0-4 ④-3 ④-2	1 2-4 ④-2 1-4	② 1-4 ④-1 ④-0		2	1			2

G ブロック		1	2	3	4	勝	負	勝G	負G	順位
1	上尾 埼玉県		1 0-4 ④-2 2-4	② 1-4 ④-0 ④-3	③ ④-2 ④-1 ④-0	2	1			2
2	富士宮西 静岡県	② ④-0 2-4 ④-2		③ ④-1 ④-1 ④-1	② 2-4 ④-1 ④-0	3	0			1
3	大河原商業 宮城県	1 ④-1 0-4 3-4	0 1-4 1-4 1-4		③ ④-1 ④-0 ④-2	1	2			3
4	茅ヶ崎北陵 神奈川県	0 2-4 1-4 0-4	1 ④-2 1-4 0-4	0 1-4 0-4 2-4		0	3			4

H ブロック		1	2	3	4	勝	負	勝G	負G	順位
1	千葉商大付 千葉県		0 1-4 2-4 0-4	② ④-3 1-4 ④-1	② 1-4 ④-2 ④-1	2	1			2
2	前橋商業B 群馬県	③ ④-1 ④-2 ④-0		② ④-0 ④-2 0-4	③ ④-2 ④-0 ④-3	3	0			1
3	小田原 神奈川県	1 3-4 ④-1 1-4	1 0-4 2-4 ④-0		1 3-4 ④-1 0-4	0	3			4
4	厚木西 神奈川県	1 ④-1 2-4 1-4	0 2-4 0-4 3-4	② ④-3 1-4 ④-0		1	2			3

会場：小田原テニスガーデン

オダワラ・キャッスル杯団体A 決勝トーナメント

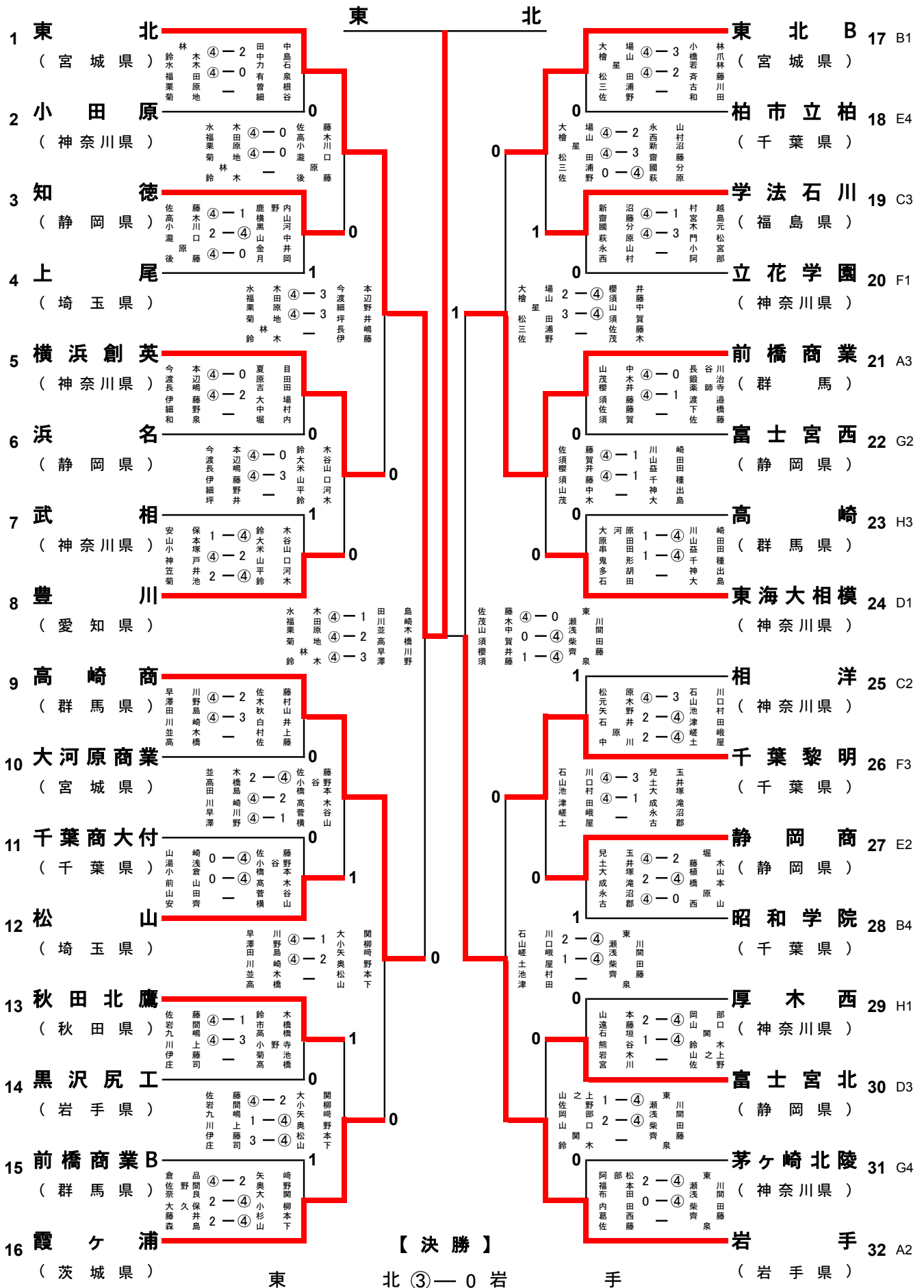

【 決 勝 】

東 北 ③—0 岩 手

水 木 ・ 福 田 ④—0 東 ・ 瀬 川
 林 ・ 鈴 木 ④—1 浅 間 ・ 柴 田
 栗 原 ・ 菊 地 ④—3 齋 藤 ・ 泉